

MCN
Monitoring and Control Network

Hot-Standby EXB Modules
and
EXB Network Manager Software
Installation and Operator Manual

S2-61044-100

Eri Products Inc. 

CTI Products Inc. License Agreement MCN EXB Network Manager Software

Single-User Products

This is a legal agreement between you, the end user, and CTI Products Inc. By opening this sealed disk package, you are agreeing to be bound by the terms of this agreement.

CTI Products Inc. Software License

- 1. GRANT OF LICENSE.** Once you have paid the required Single-User License Fee, CTI Products Inc. grants to you the right to use one copy of the enclosed software program (the "SOFTWARE"). You may use the SOFTWARE on any computer for which it is designed so long as no more than one copy of the software is in operation at any one time. You must pay for additional copies of the software if more than one copy of the software will be in use at any one time.
- 2. COPYRIGHT.** The SOFTWARE is owned by CTI Products Inc. and is protected by United States copyright laws and international treaty provisions. Therefore, you must treat the SOFTWARE like any other copyrighted material (e.g. a book or musical recording) except that you may make up to (3) copies of the SOFTWARE for archival or operational purposes. You may in no event make more than (3) copies on any media, including CDs, floppy disks, hard disks, tape, or other media. All copies of the SOFTWARE, including the original must be kept in your possession or control. You may not copy the written materials accompanying the software.
- 3. OTHER RESTRICTIONS.** You may not rent or lease the SOFTWARE, but you may transfer the SOFTWARE and accompanying written materials on a permanent basis provided you retain no copies and the recipient agrees to the terms of this Agreement. You may not reverse engineer, decompile, or disassemble the SOFTWARE. If SOFTWARE is an update, any transfer must include the update and all prior versions.
- 4. SOFTWARE UPDATES.** Any updates to this SOFTWARE which may be furnished to the end user are subject to this Agreement unless a new Agreement is included with the updated SOFTWARE.

STANDARD SOFTWARE LIMITED WARRANTY

LIMITED WARRANTY. CTI Products Inc. warrants that (a) the SOFTWARE will perform substantially in accordance with the accompanying written materials for a period of one year from the date of receipt. Any implied warranties on the SOFTWARE are limited to one year.

CUSTOMER REMEDIES. CTI Products Inc.'s entire liability and your exclusive remedy shall be, at CTI Products Inc.'s option, either (a) return of the price paid or (b) repair or replacement of the SOFTWARE that does not meet CTI Products Inc.'s Limited Warranty and which is returned to CTI Products Inc. with a copy of your receipt. This Limited Warranty is void if failure of the SOFTWARE has resulted from accident, abuse, or misapplication. Any replacement SOFTWARE will be warranted for the remainder of the original warranty period or one year, whichever is longer. THESE REMEDIES ARE NOT AVAILABLE OUTSIDE OF THE UNITED STATES OF AMERICA.

NO OTHER WARRANTIES. CTI Products Inc. disclaims all other warranties, either express or implied, including but not limited to implied warranties of merchantability and fitness for a particular purpose, with respect to the SOFTWARE, and the accompanying written materials. This limited warranty gives you specific legal rights. You may have others, which vary from state to state.

NO LIABILITY FOR CONSEQUENTIAL DAMAGES. In no event shall CTI Products Inc. or its suppliers be liable for any damages whatsoever (including, without limitation, damages for loss of business profits, business interruption, loss of business information, or other pecuniary loss) arising out of the use of or inability to use this CTI Products Inc. product, even if CTI Products Inc. has been advised of the possibility of such damages. Because some states do not allow the exclusion or limitation of liability for consequential or incidental damages, the above limitation may not apply to you.

U.S. GOVERNMENT RESTRICTED RIGHTS

The SOFTWARE and documentation are provided with RESTRICTED RIGHTS. Use duplication, or disclosure by the Government is subject to restrictions as set forth in subparagraph (c)(1)(ii) of The Rights in Technical Data and Computer Software clause at 52.227-7013. Contractor/manufacturer is CTI Products Inc, 1211 West Sharon Road, Cincinnati, Ohio 45240.

This Agreement is governed by the laws of the State of Ohio.

Should you have any questions concerning this Agreement, or if you wish to contact CTI Products Inc. for any reason, please write: CTI Products Inc., 1211 West Sharon Road, Cincinnati, Ohio 45240. (513) 595-5900

**CTI Products, Inc.
1211 W. Sharon Rd.
Cincinnati, OH 45240**

If you have questions about this software or the
MCN Remote Comparator Display system, call us at:
(513) 595-5900. (8:30 to 5:00 Eastern)

Information contained in this document is subject to change without notice and does not represent a commitment on the part of CTI Products, Inc.

No part of this manual may be reproduced or transmitted in any form or by any means, electronic or mechanical, including photocopying and recording, for any purpose without the written permission of CTI Products, Inc.

Copyright 2004 CTI Products, Inc. All rights reserved.

MCN, MCN EXB, and MCN EXB Network Manager are trademarks of CTI Products, Inc.
Other trademarks referenced are properties of their respective owners.

1.	SYSTEM OVERVIEW	1
1.1	PC REQUIREMENTS	3
1.2	REFERENCE DOCUMENTS	3
2.	HOT-STANDBY EXB OPERATION.....	4
2.1	DEFINITIONS	4
2.2	OPERATION.....	5
	NORMAL LINK CONDITION.....	6
2.4	OPEN FORWARD (PROBE) LINK CONDITION	7
2.5	OPEN REVERSE (HOLDOFF) LINK CONDITION.....	8
3.	HARDWARE INSTALLATION	9
3.1	MCN HARDWARE (EXB MODULES) INSTALLATION.....	9
3.2	SERIAL EXB DUAL PORT USE	9
3.3	PC NETWORK INTERFACE CARD INSTALLATION	10
4.	SOFTWARE INSTALLATION.....	11
5.	EXBNET CONFIG CONFIGURATION PROGRAM	13
5.1	INFORMATIONAL CUSTOM DATA	13
5.2	CRITICAL CUSTOM DATA.....	14
5.3	CONFIGURATION PROGRAM OPERATION.....	15
5.3.1	NAVIGATING IN THE PROGRAM	15
5.3.2	EDITING DATA	16
5.3.3	ADDING AN EXB CHANNEL.....	16
5.3.4	DELETING AN EXB CHANNEL.....	16
5.3.5	SAVING THE DATABASE	16
5.3.6	SAVING COLUMN SETTINGS FOR THE CONFIGURATION PROGRAM	16
5.3.7	EXPORTING THE DATABASE	18
5.3.8	IMPORTING A DATABASE	19
5.3.9	PRINTING DATA	20
5.3.10	(RE) LOADING DATA	20
5.3.11	EXITING THE CONFIGURATION PROGRAM	20
6.	NETWORK MANAGER PROGRAM OPERATION.....	21
6.1	MAIN WINDOW.....	21
6.1.1	RESIZING WINDOW & SCROLL BARS	22
6.1.2	RESIZING COLUMNS	22
6.1.3	SYSTEM EVENTS WINDOW.....	22
6.1.4	GRID DATA DEFINITION	23
6.2	FILE MENU	25
6.3	PRINTER SETUP	25
6.3.1	SELECT PRINTER	26
6.3.2	SET IDENTIFICATION PREFIX	26
6.3.3	SET INITIALIZATION STRING 1	27
6.3.4	SET INITIALIZATION STRING 2	27
6.4	OPTIONS MENU	28
6.4.1	BACKGROUND COLORS.....	28
6.4.2	STATUS BAR CHECK BOX	29
6.5	PROCESSING (ANALYSIS) STATUS INDICATION	29
6.6	MANUAL START ANALYSIS.....	29
6.7	EXB WINK FUNCTION.....	30
6.8	SYSTEM STATUS ANALYSIS & EXAMPLE SCREENS.....	31
6.8.1	NORMAL STATUS	31

Hot-Standby EXB / Network Manager Software Manual
CTI Products, Inc.

6.8.2	MAIN NETWORK DISCONNECTED:.....	32
6.8.3	MAIN WAN LINE DISCONNECTED	33
6.8.4	REMOTE MAIN EXB FAILED.....	34
6.8.5	MAIN (CENTRAL) EXB FAILED.....	35
6.8.6	REMOTE TIE LINE BAD	36
6.8.7	REMOTE STANDBY EXB FAILED	37
6.8.8	STANDBY WAN LINE BAD	38
6.8.9	STANDBY (CENTRAL) EXB FAILED	39
6.8.10	CENTRAL TIE LINE BAD.....	40
7.	APPENDIX A -- RE-INSTALLING THE EXB NETWORK MANAGEMENT PROGRAM.....	41
8.	APPENDIX B - CUSTOMER SUPPORT	42

Manual Revisions

S2-61044-100 Initial Release

1. System Overview

Hot-Standby EXB Network Extender Modules are used when added reliability is required in monitoring and controlling remote comparators. They work with CTI Products' MCN Monitoring and Control network. They provide a hot-standby dual path for the monitoring and control data.

The EXB Network Management Software runs on a PC and monitors the status of the Hot-Standby EXB modules and links. It provides the following functions:

- Status indication of EXB Modules
- Status indication of links between modules

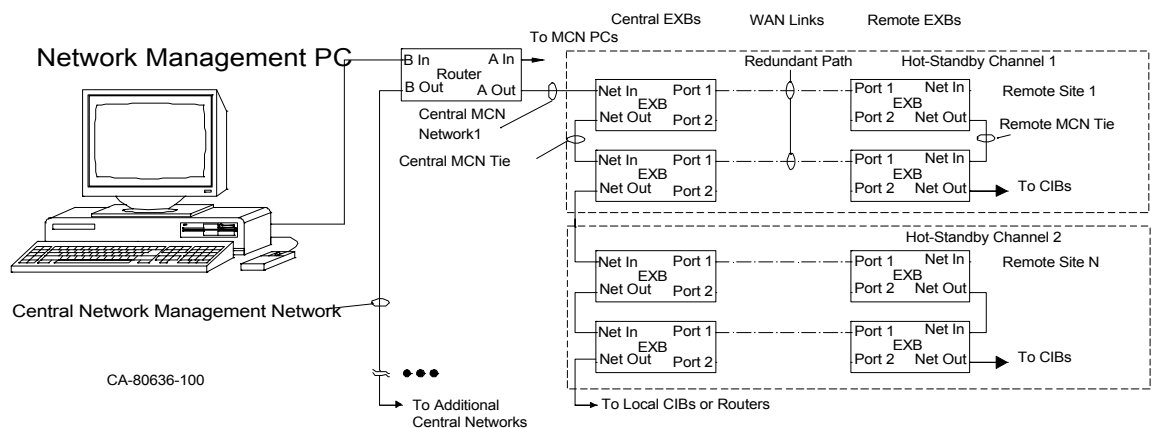

Figure 1 Hot-Standby EXB System with Network Manager PC

Figure 1 shows a typical Hot-Standby EXB system with a Network Management PC. It shows hot-standby channels to two remote sites. Not shown on the diagram are CIB modules at the remote sites or the MCN Remote Comparator Display (MCNRCD) PCs.

The figure shows a Network Management Router. These routers are used in large systems that have multiple MCN networks. In these cases, the Network Management PC sits at a higher tier than the MCNRCD PCs and manages all Hot-Standby EXB modules that feed its MCNRCD PCs. In smaller systems with only one master central network, the Network Management router is not needed.

Figure 1 shows Serial EXB Modules with two ports each. The system could contain a mix of Serial and Analog (Telco) EXB modules, depending upon the WAN links available to the remote sites. Analog (Telco) EXB Modules have only one port each. The second port on Serial units may only be used at the Remote side.

Model Number	EXB Type	
S1-60603-xxx	EXB-TELCO	1.25 Mbps Network
S1-60602-xxx	EXB-TELCO	78 Kbps Network
S1-60656-xxx	EXB-Serial	1.25 Mbps Network
S1-60655-xxx	EXB-Serial	78 Kbps Network

Table 1 EXB Modules

Table 1 shows the various types of EXB modules that can be used in a system. The "xxx" in the model number is the revision number. The revision must be 300 or above to be used in a hot-standby system. The Hot-Standby function of these units must be enabled with special programming provided by CTI Products, Inc. as part of a Custom Engineered System. 78K EXB modules are typically used at the remote sites. 1.25 Mb units are typically used at the central sites, although 78K devices could be used in some systems.

The EXB Network Management Software runs on a PC separate from the MCNRCD PC(s). The software package includes a Network Interface card for the PC.

S1-61045 EXB Network Management Package

Includes:

- S2-61005 EXB Network Management Software
- 90-11652 Network Interface 1.25 Mb PCI
- S2-61044 Manual
- S2-60617 MCN Adapter Screw Term to Dual RJ-45

If a system has multiple PC monitoring points, it can have an EXB Network Manager at each PC location. Each Network Management PC can control only those EXBs that bring data from remote sites to its own (Central) site.

For example, Table 2 shows a system with monitoring points at Site 1 and Site 2. A Yes in the table indicates that the PC can monitor the appropriate "Remote" (CIB or Group) EXBs. Notice that Site 1 cannot monitor the EXBs at its site that feed CIB data to Site 2, and vice versa.

	CIB Feeds			
	Site 1 Dispatch CIBs	Site 2 Shop CIBs	Site 3 Remote CIBs	Site 4 Remote CIBs
Site 1 Dispatch PC		Yes	Yes	Yes
Site 2 Shop PC	Yes		Yes	Yes

Table 2 Multiple Network Manager PCs

1.1 PC Requirements

Minimum PC requirements to run the EXB Network Management Software are:

- IBM Compatible PC
- Pentium III - 500 MHz processor or better
- 128 MB RAM
- 100 MB free disk space for program and support files
- CD-ROM (preferable a CD-R/W drive)
- 3.5" floppy disk drive
- SVGA adapter and monitor
- Mouse
- Sound Card & Speakers
- Windows 2000 or XP Pro
- Ethernet network card (or port)

1.2 Reference Documents

1. Monitoring and Control Network System Manual
Part Number S2-60425
2. MCN EXB Network Extender Manual
Part Number S2-60596
3. MCN Monitoring and Control Network Engineered System Installation Manual
Part Number S2-60650
4. Customer Specific System Diagrams and Configuration Documents
CA-xxxxx-xxx Drawings
KA-8xxxx-xxx Custom Configuration Disks

2. Hot-Standby EXB Operation

2.1 Definitions

EXB Channel	Everything required to implement a Hot-Standby EXB Link, including: <ul style="list-style-type: none">-Central Main EXB-Central Standby EXB-(2) Remote EXB-Main & Standby WAN Lines-Central MCN Tie Line-Remote MCN Tie Line
Central Site	The location of the MCNRCD PCs and the EXB Network Manager PC. This is the site receiving the data from the remote CIBs.
Central EXB	One of the EXB modules at the central site (where the MCNRCD PCs and the Network Management PC are) Central EXBs are sometimes referred to as "Network EXBs" since they are tied to the MCN network backbone at the MCNRCD location.
Main EXB	This is the Central EXB that normally passes traffic.
Standby EXB	This is the Central EXB that is normally in the Standby mode. It only passes traffic when a fault is detected.
Remote Site	This is the location of the CIB modules that are sending their data through the EXB Channel.
Remote EXBs	One of the EXB modules at the Remote Site. These may be referred to as the "Remote Main" or "Remote Standby" EXB to identify which WAN line it is connected to. They are also sometimes called "Group EXBs" or "CIB EXBs" since they are associated with CIB modules in a particular MCN group.
WAN Line	This is the connection between the Central Site and the Remote Site. There will be a Main Line and a Standby Line. These lines may be analog (leased telephone lines) or Serial Asynchronous (RS-232) lines, depending upon what type of EXB modules are used.

Central MCN Tie Line	This is the MCN network cabling between the Main EXB and the Standby EXB. Although it is shown as a single logical jumper in the program and on diagrams, there may actually be a number of jumpers between the Main and Standby EXBs, depending upon the exact equipment mounting.
Remote MCN Tie Line	This is the MCN Network Cabling between the two remote EXB modules in a channel. Although it is shown as a single logical jumper in the program and on diagrams, there may actually be a number of jumpers between the two EXBs, depending upon the exact equipment mounting.
Control Neuron	The processor in the EXB that controls the data flow.

2.2 Operation

The system normally passes data on the Main link. If a failure is detected, the Standby half of the channel is enabled.

System testing proceeds as follows:

1. The Main EXB module continuously probes its Standby EXB over the WAN lines.
2. The Standby EXB sends a Probe Acknowledge over the WAN lines.
3. When the Main EXB receives the Poll Acknowledge, it issues a Holdoff command to the Standby EXB over the Central Tie Line.
4. If the Standby EXB receives the Holdoff command, it will keep its channel switch turned off. It also sends a Holdoff Acknowledge to the Main EXB.
5. If the Standby EXB does not receive a Holdoff command within a fixed timer period, it enables its channel switch, passing data to and from the Remote site.

The Hot-Standby EXBs can operate without intervention from the EXB Network Management Software.

Each EXB in an EXB Channel has custom configured addresses so that the Control Neuron in the Master and Slave EXBs know the address of each other. These addresses are entered in the EXB Network Management Software Configuration Program so that the EXB Network Management Software knows the addresses of each EXB in a channel.

2.3 Normal Link Condition

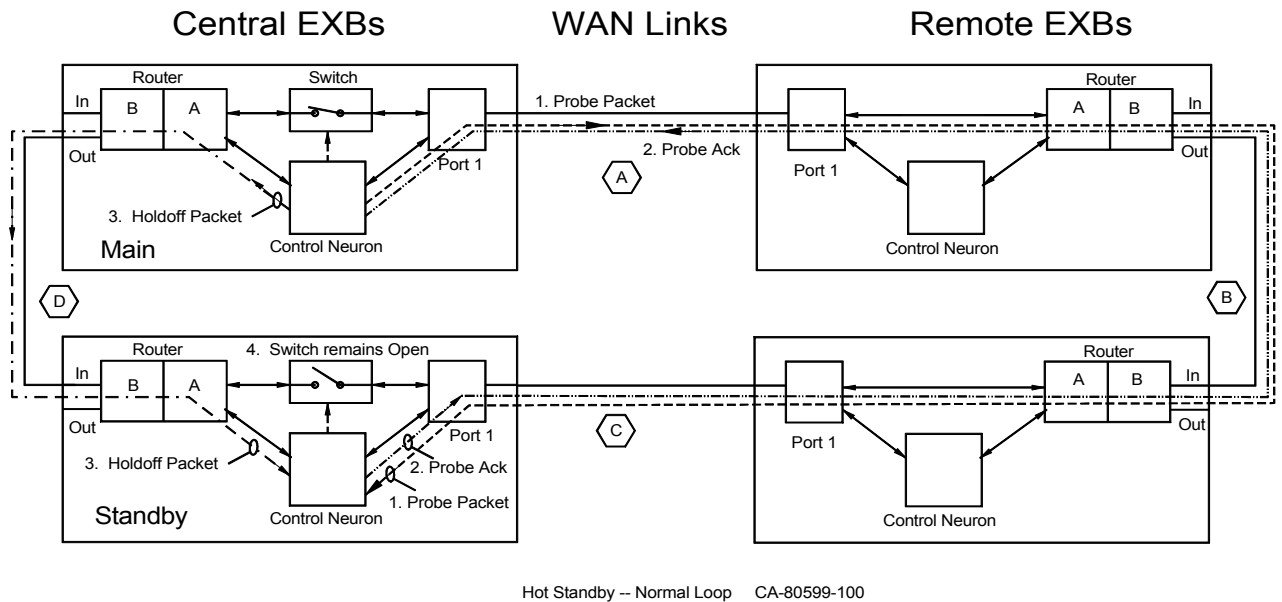

Figure 2 Normal Link Operation

In Normal Operation:

1. The Main EXB Control Neuron issues a Probe packet to the Standby EXB Control Neuron
2. The Standby Control Neuron returns a Probe ACK.
3. When the Main EXB Control Neuron receives the Probe ACK, it issues a Holdoff packet to the Standby EXB Control Neuron.
 - 3a The Standby EXB Control Neuron will return a Holdoff ACK (not shown)
4. Since the Standby EXB Control Neuron received both a Probe and a Holdoff packet, it keeps its switch open and does not pass normal MCN traffic to or from the remote site.

2.4 Open Forward (Probe) Link Condition

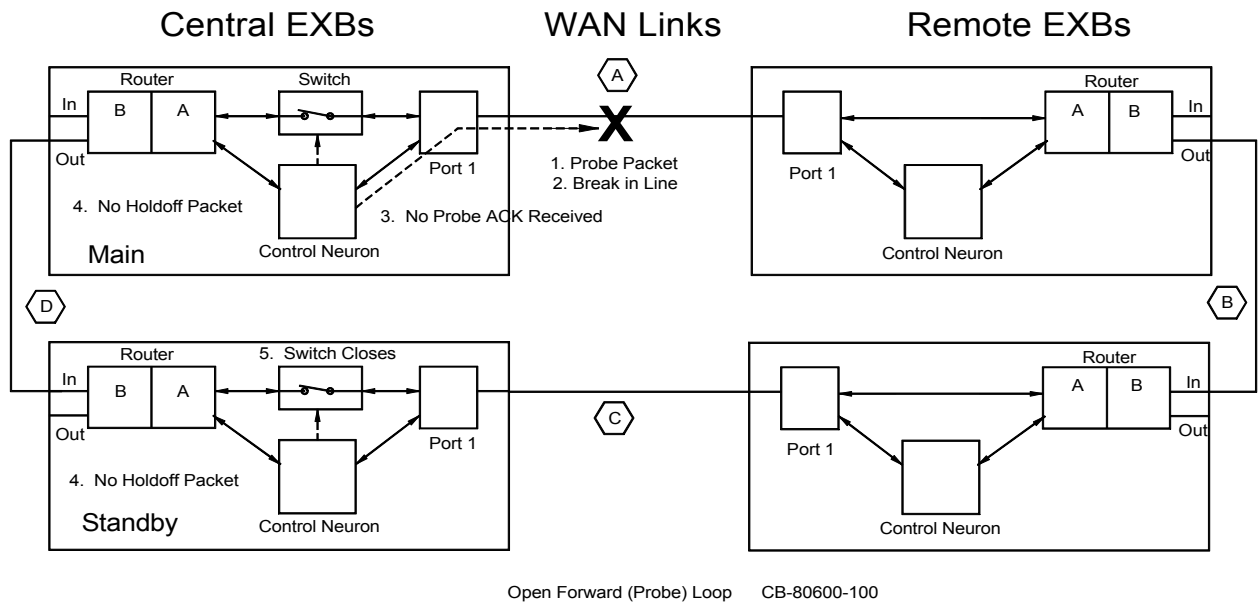
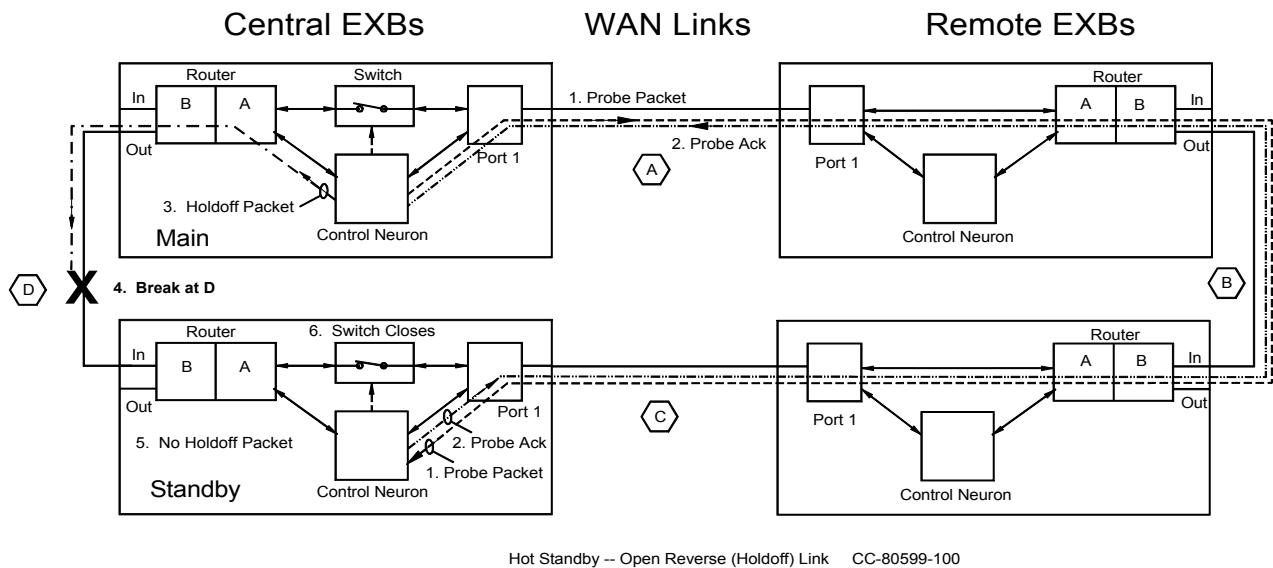

Figure 3 Open Forward (Probe) Link

With an open Forward (Probe) Link Condition:

1. The Main EXB Control Neuron issues a Probe packet to the Standby EXB Control Neuron
2. There is a break in the path. It is shown at point A, but it could occur at Point B or C.
3. The Main EXB Control Neuron does not receive a Probe ACK.
4. The Main EXB Control Neuron does not issue a Holdoff packet to the Standby EXB.
5. Since the Standby EXB Control Neuron does not receive a Probe or Holdoff packet (timeout), it closes its switch and passes MCN packets back and forth between the Central site and Remote Site on the bottom path.
6. If the break was at Point A (as shown), or the top Remote EXB was bad, all MCN traffic would pass through the bottom path.
7. If break was at Point B, both EXBs would be passing data. MCN traffic to/from the In port of the top Remote EXB would pass via the top pair of EXBs. MCN traffic to/from the Out port of the bottom Remote EXB would pass via the bottom pair of EXBs.
8. If the break was at Point C, the standby EXB would still close its switch, but there would be no traffic over the bottom path. The Standby EXB would know that the link was down because of its link layer diagnostics.
9. Since the Main EXB does not receive a Holdoff Acknowledge, it informs the EXB Network Management Software of a problem.

2.5 Open Reverse (Holdoff) Link Condition



Hot Standby -- Open Reverse (Holdoff) Link CC-80599-100

Figure 4 Open Reverse (Holdoff) Link

1. The Main EXB Control Neuron issues a Probe packet to the Standby EXB Control Neuron
2. The Standby Control Neuron returns a Probe ACK.
3. When the Main EXB Control Neuron receives the Probe ACK, it issues a Holdoff packet to the Standby EXB Control Neuron.
4. There is a break on the Central MCN Tie line.
5. The Holdoff Packet is not received.
6. Since the Standby EXB Control Neuron does not receive a Holdoff packet (timeout), it closes its switch and passes MCN packets back and forth between the Central site and Remote Site on the bottom path.
7. Both Central EXBs will have their switches closed.
 The MCN traffic to and from the IN port of the Central Main (Top) EXB will pass over the top link.
 The MCN traffic to and from the OUT port of the Central Standby (Bottom) EXB will pass over the bottom.
8. Since the Main EXB does not receive a Holdoff Acknowledge, it informs the EXB Network Management Software of a problem.

3. Hardware Installation

3.1 MCN Hardware (EXB Modules) Installation

Hardware must be installed in accordance with the following documents which are listed from most system-specific to most generic. In the case of any discrepancy, the documents first in the list shall take precedence.

1. Customer Specific System Diagrams and Configuration Documents
CA-xxxxx-xxx Drawings
KA-8xxxx-xxx Custom Configuration Disks
2. MCN Monitoring and Control Network
Engineered System Installation Manual
Part Number S2-60650
3. MCN EXB Network Extender Manual
Part Number S2-60596
4. Monitoring and Control Network System Manual
Part Number S2-60425

Since all EXB modules have custom addresses, they must be installed as per the customer specific documents.

If a system is pre-configured at the factory, the EXB modules will be labeled appropriately.

If a system is not pre-configured, the EXB modules must each be programmed appropriately with the custom scripts provided in the Customer Configuration Disk(s). See the instructions with the Customer Specific System Drawings.

When Serial EXB modules are used, be sure to set the Baud Rate switches on the back of the units to the WAL Line data rate being used. 19.2K or higher is recommended. Be sure to use Asynchronous Serial channels for the WAN line.

When Analog (Telco) EXB units are used, be sure to set the wireline 2W/4W ,TX Level (-10 / -16 dBm), and Answer/Originate option switches as appropriate (see Customer Specific information and the EXB manual.)

3.2 Serial EXB Dual Port Use

Serial EXBs have two serial ports. The following rules govern the use of those ports:

1. Remote EXBs (CIB EXBs) can use 1 or 2 ports. They can feed multiple MCNRCD display positions. If two EXB Network Management Software PCs are running, both can see this remote EXB.
2. Central EXBs can use only 1 port.

3.3 PC Network Interface Card Installation

Install the EXB Network Management Software first.
(See Section 4)

If you have completed the software driver installation, it is finally time to install the Gesytec Easylon Network Interface card (CTI Part Number 90-11652.)

- a. Turn off the PC and remove the power cord.
- b. Open the PC case and locate an empty slot.
- c. Remove the corresponding blank panel from the rear of the PC.
- d. Insert the Network Interface card into the slot, ensuring that the edge connectors are fully mated, and the slot in the rear panel-mounting lug of the Network Interface card is aligned with the threaded hole in the PC chassis.
- e. Replace the screw to hold the card firmly in place.
- f. Close the PC.
- g. Reinsert the power cord and then restart the PC. A “New Hardware Found” window will be displayed briefly when the operating system recognizes the Network Interface card.
- h. The S2-60617 MCN Adapter Screw Term to Dual RJ-45 has a pluggable screw terminal installed on it, but it fits only the PCLTA module. The EXB Network Management Software Network Interface uses a different terminal strip. Remove the terminal strip from the adapter and attach the cable to the screw terminal that ships with the Network Interface card.
- i. Connect the MCN network cable(s) to the adapter. If only one cable is specified, connect a 1250 terminator to the second RJ-45 jack.

4. Software Installation

This section describes the installation of the MCN EXB Network Management Software in a PC.

If you are installing the software as an update to a previous version or re-installing the software, you must remove the previous version first. Please refer to Appendix A -- Re-Installing the *EXB Network Management* Program for instructions.

To install the software:

1. Make sure you have Administrator privileges on the PC.
2. Close all running programs.
3. Insert the CD in the CD drive.
From the Start menu, select Run and type in:
 d:\setup.exe
(where d is your CD-ROM drive letter).
4. Follow the instructions in the InstallShield install program.
5. The InstallShield program will install the program in a working directory.
The default working directory is:
 c:\Program Files\CTI Products Inc\ExbNetManager.
6. After the files are copied, the PC must be re-started.
7. After you re-start the PC, turn it off again.
8. Install the Gesytec EasyLon Network Interface Card as described in section 3.3 of this manual.
9. Re-start the PC.

10. Verify that the Gesytec EasyLon Network Interface is installed correctly.
 - Go to Control Panel / System Properties / Device Manager.
 - Click on LON Adapters / Gesytec.
 - Go to the Advanced Tab.
 - Click on the Adapter Name.
 - Be sure it is set for LPP1. If not, change it to read LPP1.
 - Close the windows.

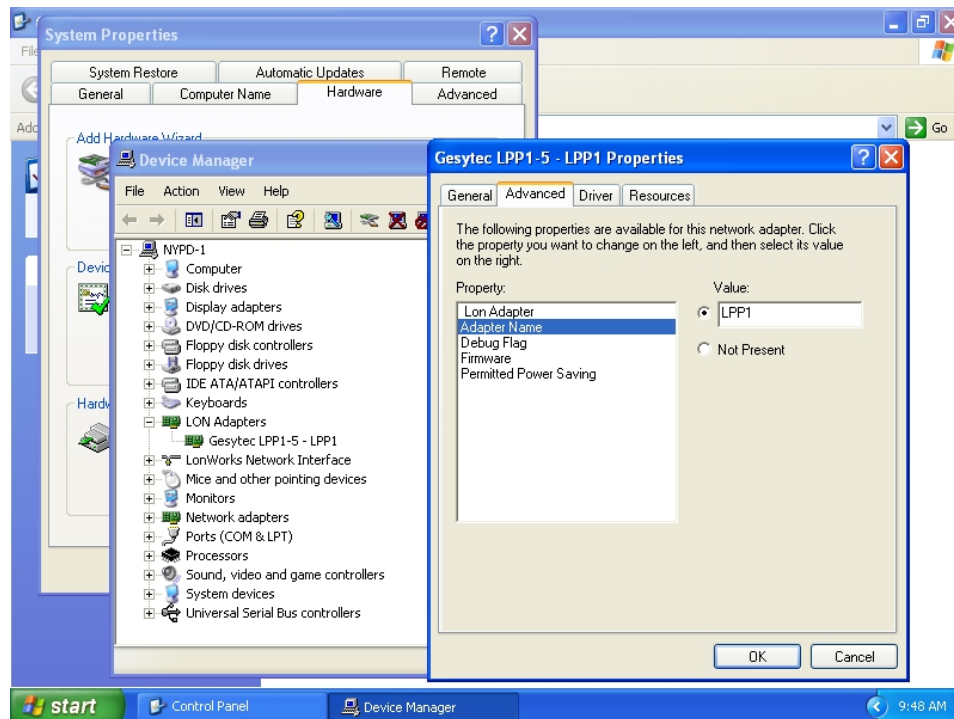

Figure 5 Network Interface Properties Window

11. If the custom files have been factory-generated for the EXB Network Management Software, they will be on the Customer Specific Disk(s). Copy the following file to the working directory:
MCNChannels.dat
12. If the custom files were not included, run the EXBNet Config program to generate the channel configuration. Use the data furnished by CTI products, Inc.

The InstallShield program will add shortcuts for the EXBNet Config program and the EXB Network Manager programs to the CTI Products folder on the desktop.

5. EXBNet Config Configuration Program

This program allows you to enter or modify data for each EXB Channel in your system. It also allows you to export or import that data to or from .CSV files. It should only be used by system administrators. **Improper data can cause the EXB Network Management Software program to malfunction.**

5.1 Informational Custom Data

This data will be displayed on the screen and on error reports. It is used to help you diagnose system problems.

The User Defined data may be changed as required. Other data should contain at least the data that is specified in the Customer Specific information package.

- **MCN Network (Numeric)**
(Informational. Should match Network Name in Customer Specific package)
- **Radio Channel (User Defined)**
(Informational. Identifies which radio channel traffic is being passed through this EXB channel.)
- **Remote MCN Group Number**
(Informational. Should match Remote Group Number in Customer Specific package)
- **Main EXB Name**
(Informational. Should match Central Main EXB Name in Customer Specific package and on the label for the Main EXB for this channel))
- **Main (WAN) Line Name (User Defined)**
(Informational. Main Phone Line, Microwave, or T1 channel identifier)
- **Main Remote EXB Name**
(Informational. Should match Main Remote EXB Name in Customer Specific package and on the label for the Main Remote EXB for this channel))
- **Main Remote EXB Port Number**
(Informational. Always port 1 for Analog (Telco) EXBs.
For Serial EXBs, this indicates which port is being used on this link.)
- **Standby EXB Name**
(Informational. Should match Central Standby EXB Name in Customer Specific package and on the label for the Standby EXB for this channel))
- **Standby (WAN) Line Name (User Defined)**
(Informational. Standby Phone Line, Microwave, or T1 channel identifier)
- **Standby Remote EXB Name**
(Informational. Should match Standby Remote EXB Name in Customer Specific package and on the label for the Standby Remote EXB for this channel))

- **Standby Remote EXB Port Number**
(Informational. Always port 1 for Analog (Telco) EXBs.
For Serial EXBs, this indicates which port is being used on this link.)

5.2 Critical Custom Data

This data is the system-specific data for each of the EXB modules. It tells the EXB Network Management Software the appropriate addresses for each EXB module.

This data must be entered exactly as specified in the Customer Specific Package shipped by CTI Products.

- **Main Near Router Subnet & Node (Hex)**
Address for MCN Network side of internal router in Central Main EXB
- **Main Far Router Subnet & Node (Hex)**
Address for WAN side of internal router in Central Main EXB
- **Main Control Subnet & Node (Hex)**
Address for Control Neuron (Control processor) in Central Main EXB

- **Main Remote Near Router Subnet & Node (Hex)**
Address for WAN side of internal router in Main Remote EXB
- **Main Remote Far Router Subnet & Node (Hex)**
Address for MCN Network side of internal router in Main Remote EXB
- **Main Control Subnet & Node (Hex)**
Address for Control Neuron (Control processor) in Main Remote EXB

- **Standby Near Router Subnet & Node (Hex)**
Address for MCN Network side of internal router in Central Standby EXB
- **Standby Far Router Subnet & Node (Hex)**
Address for WAN side of internal router in Central Standby EXB
- **Standby Control Subnet & Node (Hex)**
Address for Control Neuron (Control processor) in Central Standby EXB

- **Standby Remote Near Router Subnet & Node (Hex)**
Address for WAN side of internal router in Standby Remote EXB
- **Standby Remote Far Router Subnet & Node (Hex)**
Address for MCN Network side of internal router in Standby Remote EXB
- **Standby Control Subnet & Node (Hex)**
Address for Control Neuron (Control processor) in Standby Remote EXB

Note that "Near" and "Far" refer to the sides of the internal router that are closer or further from the EXB Network Management Software PC.

5.3 Configuration Program Operation

When the program is started, it will come up in one of two states:

1. A Blank screen if MCNChannels.dat is missing or blank
2. A screen with channel information if MCNChannels.dat has valid data.

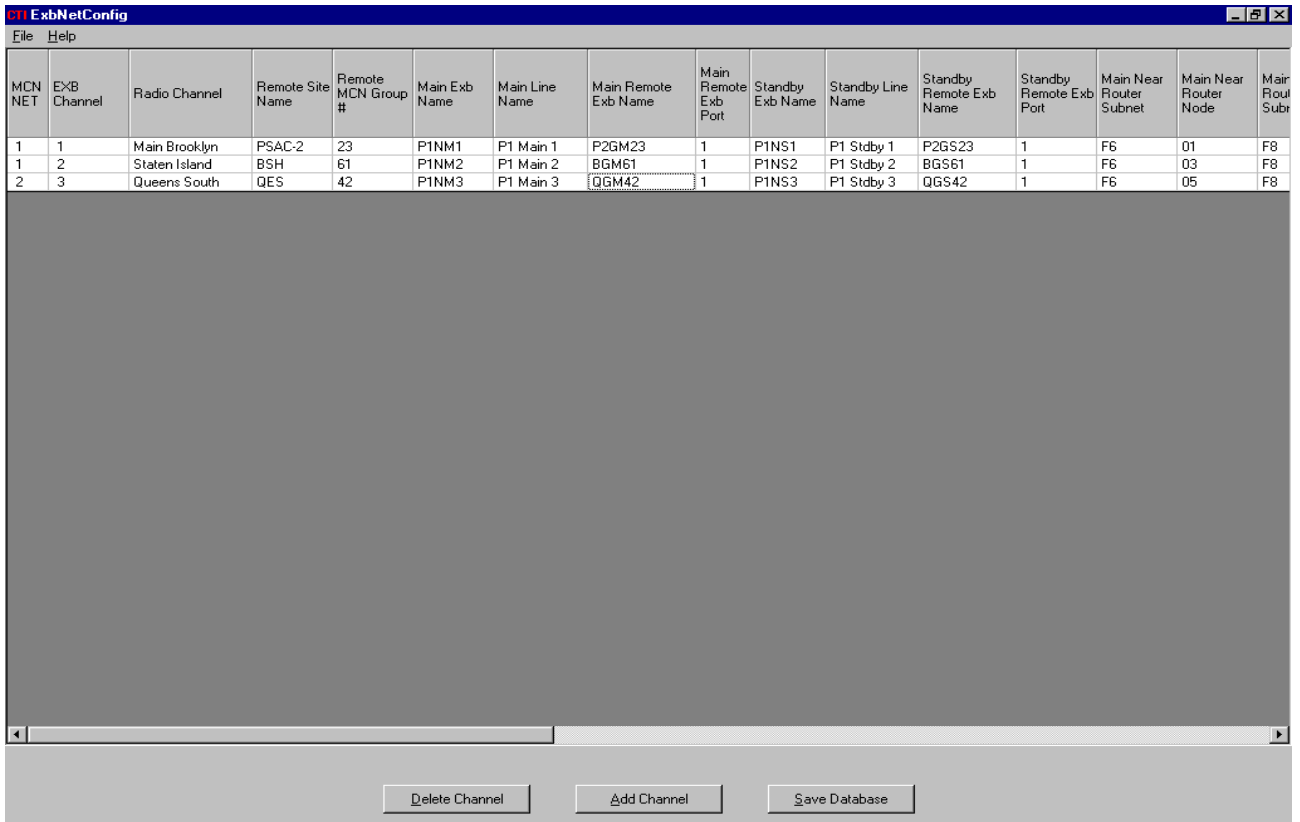

Figure 6 Typical Configuration Screen

5.3.1 Navigating in the Program

The program functions like a typical Windows program.

- To **move between cells**, use the mouse or arrow keys
- To **see a portion of the database that is off the screen**, use the Scroll bar(s).
- To access **menu functions**, use the mouse hit Alt-F (for File) or Alt-H (for Help).
- To access the **bottom buttons**, click on them with a mouse or hit the Ctrl key along with the indicated shortcut.

- To change a **column width**, move your mouse over a column separator into the top row. The cursor will change to a double arrow. Drag the column to the desired width.

5.3.2 Editing Data

To Edit data, move the cursor to the field and click. Enter data from the keyboard. When you are finished in that field, hit Enter or any of the cursor arrows to move to another field.

Some fields are limited to numeric or Hex values. If you type a non-numeric or non-hex value, a warning window will pop up.

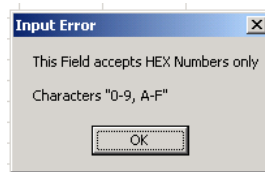

Figure 7 Input Error Window

5.3.3 Adding an EXB Channel

To add an EXB channel, hit the *Add Channel* button or type <Ctrl-A>. A blank channel will be added to the bottom of the list.

5.3.4 Deleting an EXB Channel

To delete an EXB channel, move the cursor to the channel you want to delete. Hit the *Delete Channel* button or type <Ctrl-D>.

5.3.5 Saving the Database

To save the database, hit the *Save Database* button or type <Ctrl-S>.

Only one custom configuration file is used in the EXB Network Management Software, MCNChannels.dat. The configuration program saves to this file.

Warning
You must save the database before you exit.
The program does not prompt you to save changes.

When you Save a database, the EXB Network Management Software program will use that database the next time is started.

5.3.6 Saving Column Settings for the Configuration Program

To save the column settings used in the Configuration program, select the *Save Column Settings* option from the *File* menu:

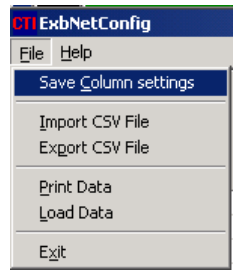

Figure 8 File / Save Column Settings

5.3.7 Exporting the Database

You can export a database to a Comma Separated Variables (.CSV) file for use with a program such as Excel.

Another use for the Export feature is if you are making changes to your database but don't want to use them right away. You can save the new version of the database to a temporary CSV file and import it later and save it later to the main database.

To Export a database, select the *Export CSV File* option from the *File* menu.

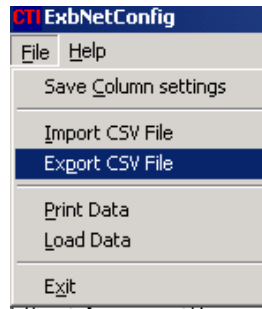

Figure 9 File / Export CSV File Menu

You will be prompted for a file name.

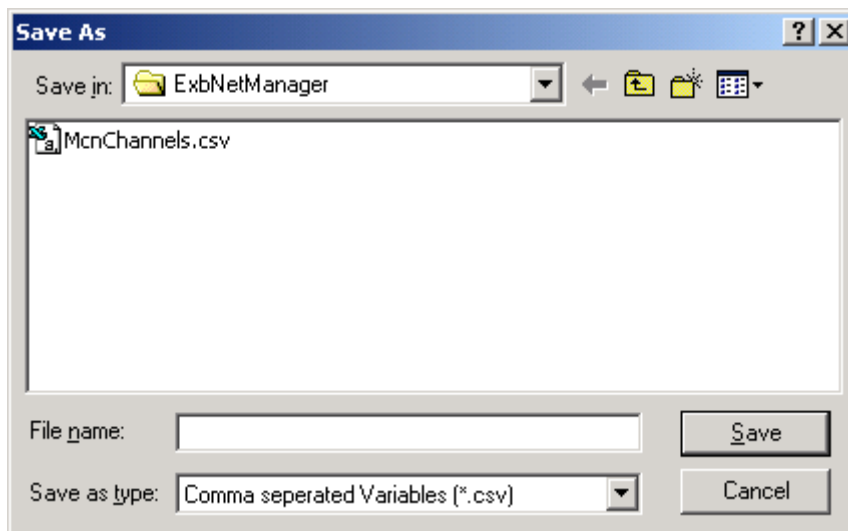

Figure 10 Export Window

Enter the file name and hit the *Save* button.

5.3.8 Importing a Database

You can import a database from a Comma Separated Variables (.CSV) file.

To Import a database, select the *Import CSV File* option from the *File* menu.

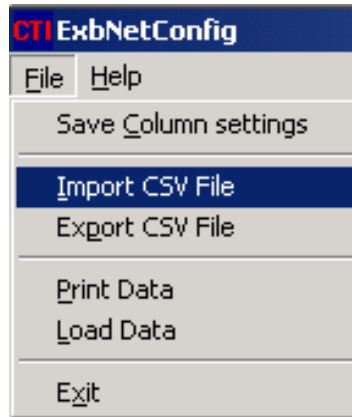

Figure 11 File / Import CSV File Menu

You will be prompted for a file name.

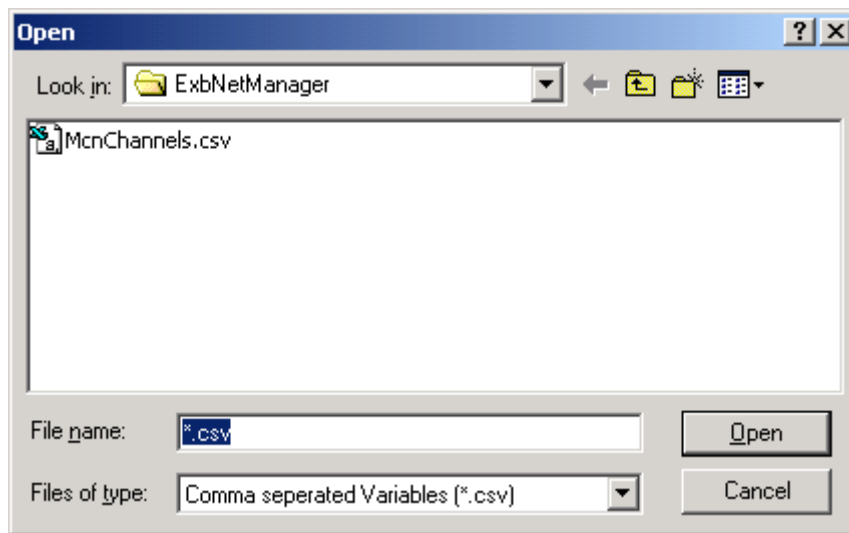

Figure 12 Import CSV Window

Select the appropriate file, and hit the *Open* button. The database will appear on the screen. If you want to use this database, be sure to hit the Save Database button on the bottom of the screen.

5.3.9 Printing Data

You can print the data to a printer. It is recommended that you use an 11 x 17" sheet in landscape mode. (It may be better to export the data in CSV format and print it from a spreadsheet.)

To Print the data, select the *Print Data* option from the *File* menu.

5.3.10 (Re) Loading Data

If you have made a mistake and want to re-load the data from the main data file (MCNChannels.dat), select the *Load Data* option from the *File* menu.

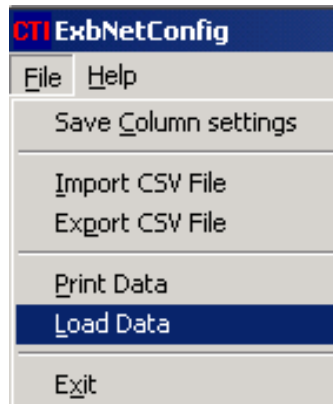

Figure 13 File / Load Data Menu

5.3.11 Exiting the Configuration Program

To exit the program, select the *Exit* option from the *File* menu.

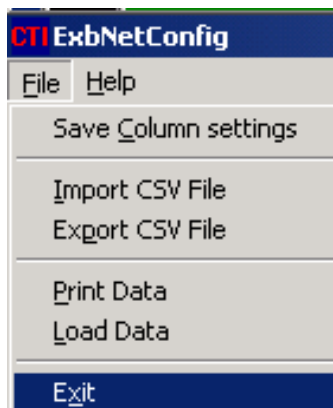

Figure 14 File / Exit Menu

Warning
If you have made changes that you want to keep,
you must save the database before you exit.
The program does not prompt you to save changes.

6. Network Manager Program Operation

The EXB Network Management Software program will:

1. Display the status of the Hot-Standby EXB system.
2. Log Errors to Disk and/or Printer
3. Perform (limited) diagnostics to help isolate problems.

6.1 Main Window

The main window opens with a list of all the EXB channels defined in the data base.

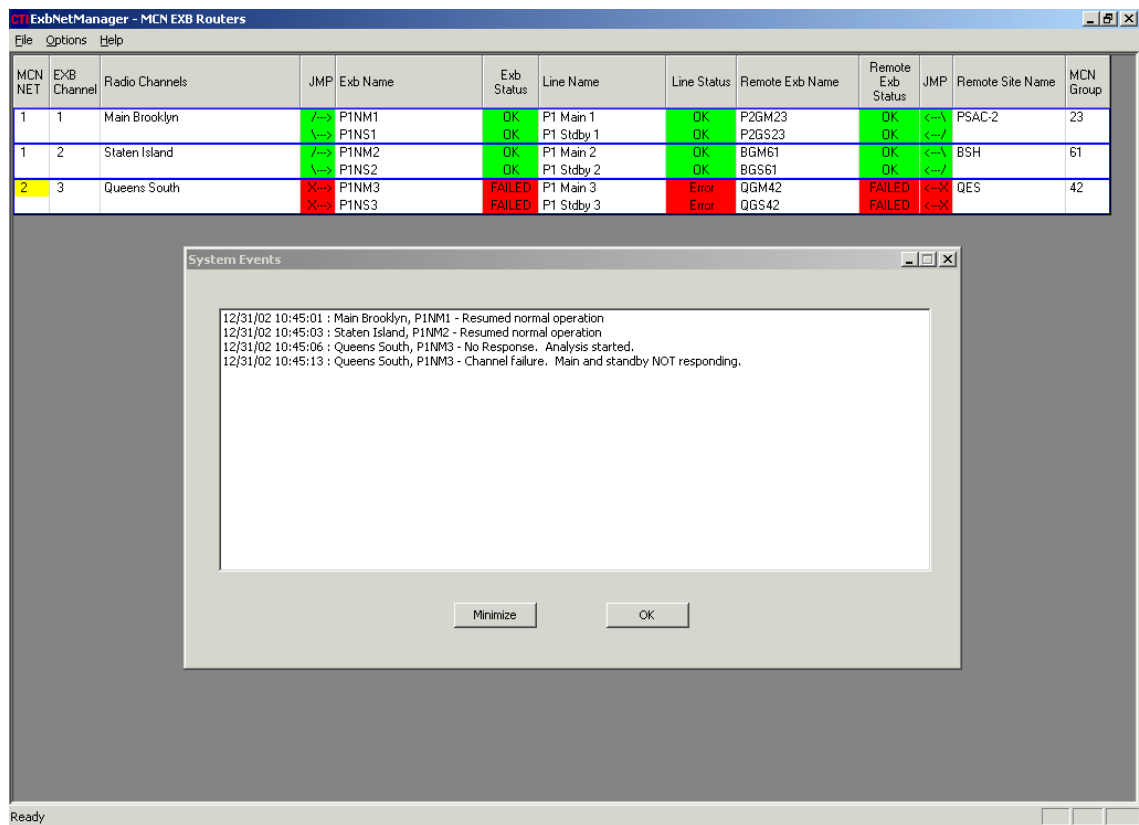

Figure 15 -- EXB Network Management Software Main Window

The display is configured to display each EXB channel in a text grid similar to the channel diagram as shown in Figure 2.

6.1.1 Resizing Window & Scroll Bars

The window may be re-sized as any standard Windows program by dragging one of the window edges or corners.

If the window is too small for the entire system, scroll bar(s) will appear.

6.1.2 Resizing Columns

Columns may be re-sized to fit the data better. To change a **column width**, move your mouse over a column separator into the top row. The cursor will change to a double arrow. Drag the column to the desired width. If you want to save the column widths, use the **File / Save Column Settings** command.

6.1.3 System Events Window

When the state of an EXB unit changes, a System Events window will appear with information about the event.

Hitting the Minimize button will keep the current data. The next event will bring up the window again with the new data added to the end of the original data.

Hitting the OK button will clear and close the window. The next event will bring up the window with only the new event data.

6.1.4 Grid Data Definition

Each EXB channel is shown as two lines. The channels are separated from each other by a heavy blue line. The top row for each channel is for the Main path, and the bottom row is for the Standby path. (The status colors shown below are the default colors as shipped with the software. If you change the colors all bets are off.)

MCN Net	The MCN Network that is defined in the database for this EXB Channel.	
EXB Channel	EXB Channel number defined in the database	
Radio Channel	Radio channel associated with this EXB channel as defined in the database.	
JMP (Left)	Shows the status of the Central MCN Tie lines.	
Green	/→ \→	(Looks like a jumper) Connection is OK
Red	X→	The connection is broken
Gray	???	There is a problem but the program doesn't have enough information to determine the status of the jumper.

Remember that the MCN Tie line as shown here is a logical connection. Physically, this tie line can be a series of jumpers, depending upon the actual equipment racking.

EXB Name (Left)	Shows the Central EXB names as defined in the database. The top name in a pair of rows is the Central Main EXB. The bottom name is the Central Standby EXB.	
EXB Status (Left)	Shows the status of the Central EXBs. The top status in a pair of rows is for the Main EXB. The bottom status is the Central Standby EXB.	

Green OK	Functioning Properly
	Main EXB = passing data
	Standby EXB = not passing data (switch off)

Red Failed Program cannot talk to EXB

Gray ??? There is a problem but the program doesn't have enough information to determine the true status of the EXB

	Yellow Switch	(Standby EXB only) The Standby EXB is not receiving a Holdoff command and has turned its network switch on.
Line Name		WAN Line Name for the Main (top) or Standby (bottom) EXB as defined in the database. This is typically a telephone microwave or T1 line number which can be used to troubleshoot the system.
Line Status		Status of the WAN Line for the Main (top) or Standby (bottom) EXB as determined by the program
	Green OK	Functioning Properly
	Red Error	Line bad
	Gray ???	There is a problem but the program doesn't have enough information to determine the true status of the line
Remote EXB Name		Shows the Remote EXB names as defined in the database. The top name in a pair of rows is the Remote Main EXB. The bottom name is the Remote Standby EXB.
Remote EXB Status		Shows the status of the Remote EXBs. The top status is for the Remote Main EXB. The bottom status is the Remote Standby EXB.
	Green OK	Functioning Properly
	Red Failed	Program cannot talk to EXB
	Gray ???	There is a problem but the program doesn't have enough information to determine the true status of the EXB
		Remote units do not have the "Switch" function.
JMP (Right)		Shows the status of the Remote MCN Tie lines. Same status indications as the JMP (Left) column.
Remote Site Name		Shows the Remote Site Name as defined in the database. There may be multiple EXB channels to a particular remote site, serving various radio channels, depending upon the network configuration.
MCN Group		MCN Group Number for the CIBs attached to this EXB channel, as defined in the database.

6.2 File Menu

The File Menu on the Main Window has the following options:

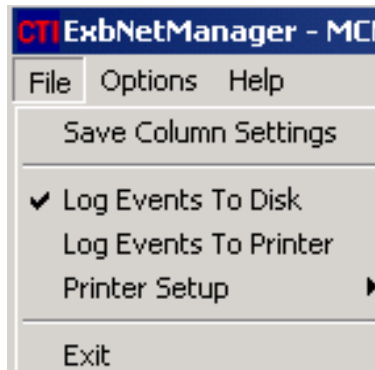

Figure 16 Network Manager File Menu

- Save Column Settings** Saves the current column settings. These settings will be used the next time the program is re-started.
- Log Events to Disk** This check-box option turns on disk logging. The logging file is **EventLog.txt**.
- Log Events to Printer** This check-box option turns on printer logging. You must set up a printer with the **Printer Setup** command.
- Printer Setup** Selects a printer to use and appropriate setup strings.
- Exit** Exits the program.

6.3 Printer Setup

The EXB Network Management Software program can send error events to a printer. The **File / Printer Setup** menu item allows you to select a printer and set up its setup strings.

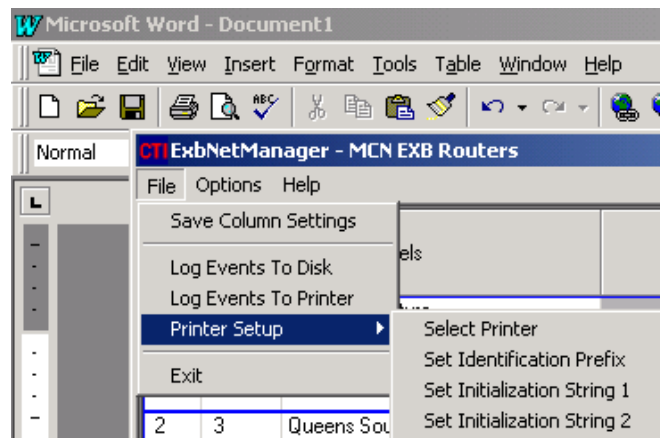

Figure 17 Printer Setup Menu

6.3.1 Select Printer

The **Select Printer** dialog box allows you to select either a local or a network printer. Typically, dot-matrix line printers are used, since error events are only a few lines long and do not generate a whole sheet of data.

Navigate to the desired printer and hit the **Select** button.

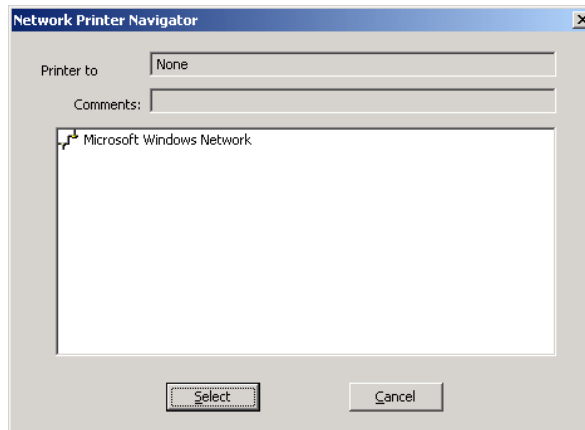

Figure 18 Selet Printer Dialog Box

6.3.2 Set Identification Prefix

If the program is using a shared printer, you may wish it to send an identification prefix before each line of data. In this way, you can tell which PC each line of data came from. Use the **Set Identification Prefix** dialog box for this purpose.

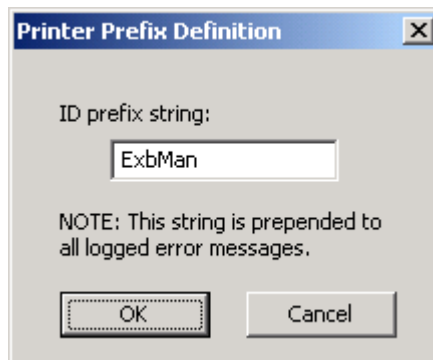

Figure 19 Set Identification Prefix Dialog Box

6.3.3 Set Initialization String 1

The program can send two initialization prefixes whenever it starts.

Initialization String 1 is typically used to put the printer into compressed print mode.

Use the **Set Initialization String 1** dialog box to enter the first Initialization String.

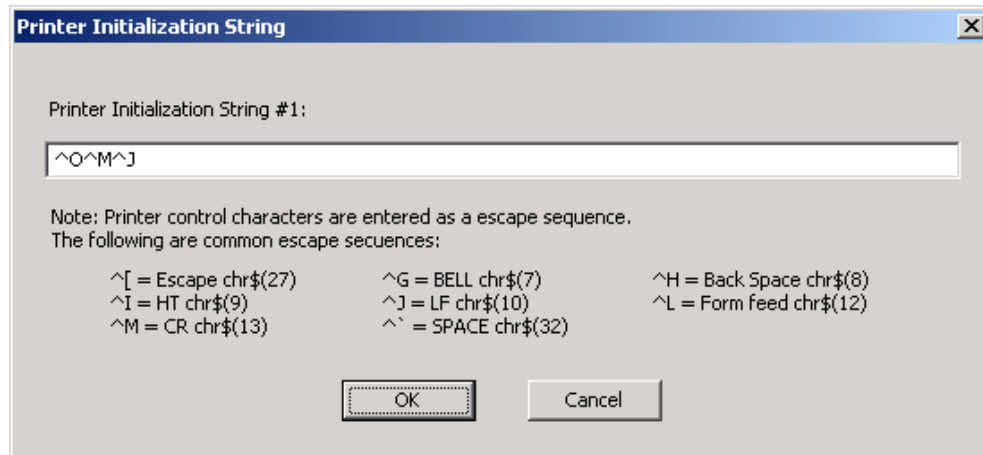

Figure 20 Set Initialization String 1 Dialog Box

6.3.4 Set Initialization String 2

Initialization String 2 is typically used to generate column headings when the program starts.

Use the **Set Initialization String 2** dialog box to enter the second Initialization String.

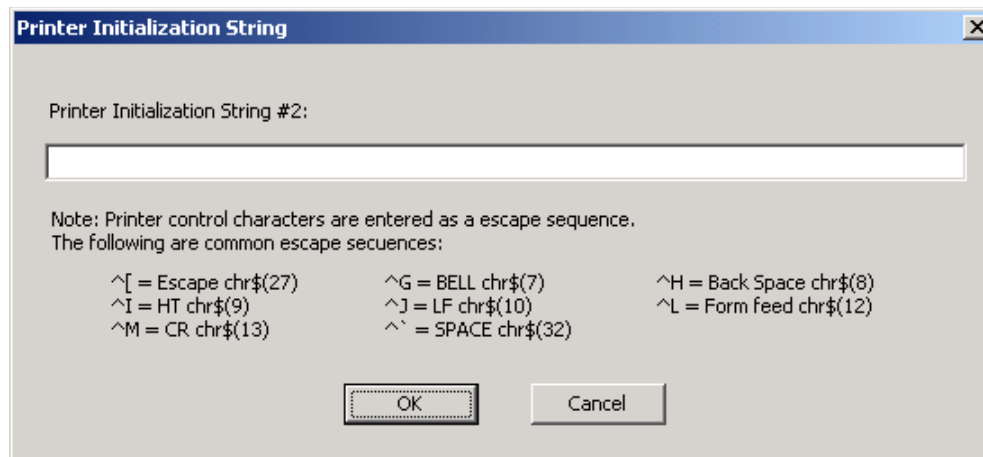

Figure 21 Set Initialization String 2 Dialog Box

6.4 Options Menu

From the **Options** menu, you can change the **Background Colors** for the various status conditions and enable or disable the **Status Bar**.

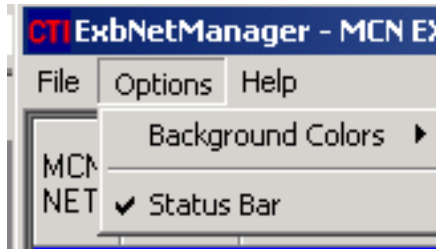

Figure 22 EXB Network Manager Options Menu

6.4.1 Background Colors

The **Background Colors** menu allows you to change the background colors of the following status conditions:

- Error
- Caution
- Normal
- Unknown
- Processing

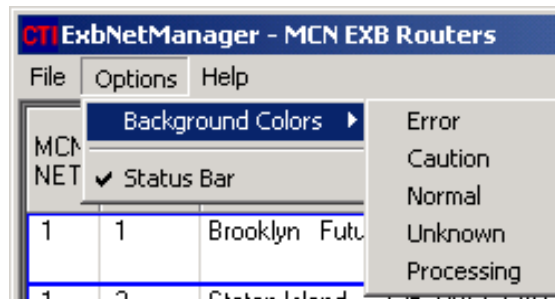

Figure 23 EXB Network Manager Background Colors Menu

Note that the colors for the status indications shown in this manual are based upon the default color configuration that ships with the software.

Selecting an item will bring up the Color Selection Dialog Box.

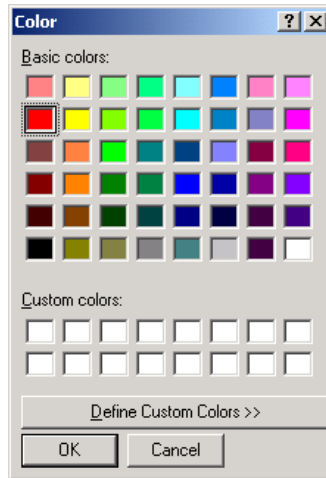

Figure 24 Color Selection Dialog Box

6.4.2 Status Bar Check Box

This check box turns the Status Bar on the bottom of the screen On & Off.

6.5 Processing (Analysis) Status Indication

The program will scan each EXB channel to check its status. The EXB Channel field will change color to indicate which channel the program is analyzing.

6.6 Manual Start Analysis

To force the program to analyze a particular channel, double-click anywhere in that EXB channel row. The **Start Analysis** window will appear. Click on **Start Analysis**. The program will Queue up that channel for analysis next.

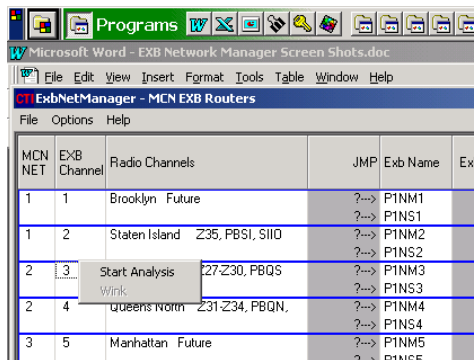

Figure 25 Start Analysis Window

(The Wink option is not enabled since the user didn't click directly on an EXB name, but rather on the channel number.)

6.7 EXB Wink Function

Since there can be many EXB modules in a system, it is helpful to be able to verify which physical EXB module corresponds to the unit on the screen. The program has a Wink EXB function that will help identify an EXB in the field. When the Wink EXB function is activated, the PWR LED on the EXB module will wink.

MCN NET	EXB Channel	Radio Channels	JMP	Exb Name	Exb Status	Line Name
1	1	Brooklyn Future	?-->	P1NM1 P1NS1	???	T1 to PSAC-2 Future uW to PSAC-2 Future
1	2	Staten Island Z35, PBSI, SIID	?-->	P1NM2 P1NS2	???	74DHDA411470-24 uW to BSH Future
2	3	Queens South Z27-Z30, PBQS	?-->	P1NM3 P1NS3	Start Analysis Wink	74DHDA411629-24 W to QES Future
2	4	Queens North Z31-Z34, PBQN,	?-->	P1NM4 P1NS4	???	74DHDA411627-24 uW to QES Future
3	5	Manhattan Future	?-->	P1NM5 P1NS5	???	T1 to PSAC-2 Future uW to PSAC-2 Future

Figure 26 Start Analysis / Wink EXB Window

To Wink an EXB, double-click on the desired EXB name. The **Start Analysis / Wink** window will appear. Click on **Wink**.

(Since the EXB Name is in the channel row, the Start Analysis option is also enabled.)

6.8 System Status Analysis & Example Screens

The EXB Network Management Software program tries to analyze the system to the best of its ability. It presents its best guess as to what is wrong in the system.

When a Main EXB notices a change in state of its Standby EXB, it will notify the program. The program will start an analysis on that EXB channel.

It will try to communicate to all EXB units first in the forward direction (Clockwise -- the Probe direction as shown in Figure 3).

It will then try to communicate to all EXB units first in the reverse direction (Counter-Clockwise -- the Holdoff direction as shown in Figure 3).

It can take about 5-10 seconds to analyze a failed EXB channel.

Based upon the responses, the program will then determine what the most likely failure is. Do not take its recommendations as absolute truth. Sometimes there are other failures that can result in the same display. The program is presenting the most likely problem. Some alternate problems are shown in the following status displays.

6.8.1 Normal Status

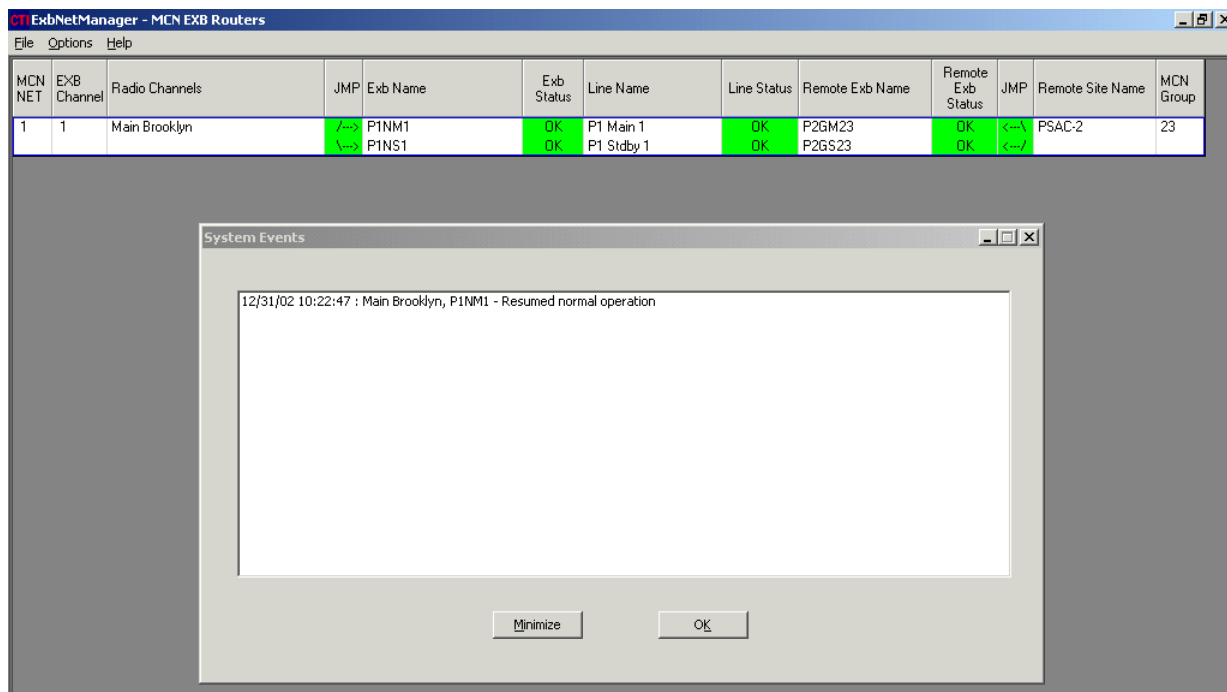

Figure 27 Normal Status

When everything is normal, all status fields are Green (or the Normal color you have defined).

6.8.2 Main Network Disconnected:

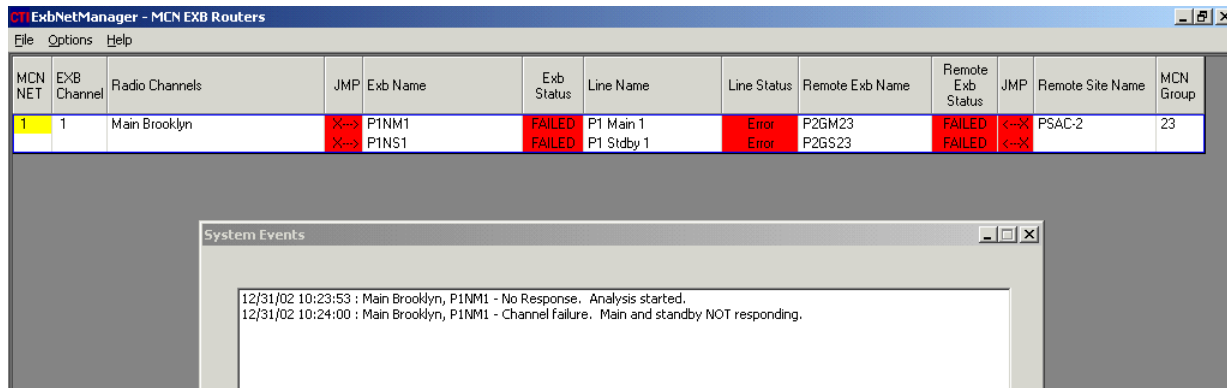

Figure 28 Main Network Disconnected

When the EXB Network Management Software PC is disconnected from the EXB channel, it cannot see any of the EXB modules.

This could be a disconnected cable or a Network Management Router problem.

6.8.3 Main WAN Line Disconnected

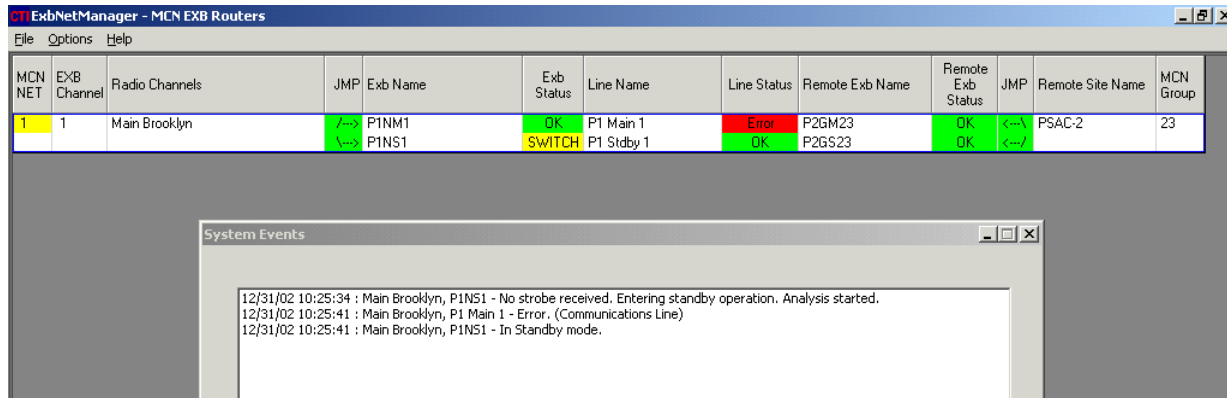

Figure 29 Main WAN Line Disconnected

Since the loop is not complete, the Standby EXB turns on its network switch to pass traffic over the Standby WAN line.

In this condition, the program can talk to the units as follows:

EXB	Forward (Clockwise)	Reverse (Counter-Clockwise)
Main (Central)	Yes	No
Standby (Central)	No	Yes
Remote Standby	No	Yes
Remote Main	No	Yes

Based upon this, the program determines that the Main WAN Line is bad.

Other possible causes for this display could be:

1. A bad cable from one of the EXBs to the Main WAN line.
2. Bad Main Central or Main Remote EXB Module.
 Possibly a bad modem in an Analog / Telco EXB unit
 Possibly a bad serial port on a Serial EXB unit.

6.8.4 Remote Main EXB Failed

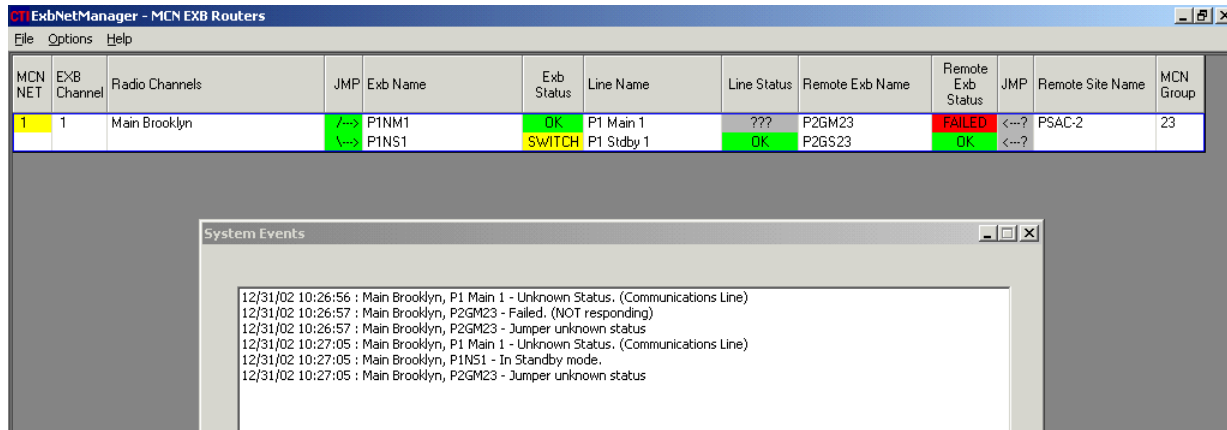

Figure 30 Remote Main EXB Failed

Since the loop is not complete, the Standby EXB turns on its network switch to pass traffic over the Standby WAN line.

In this condition, the program can talk to the units as follows:

EXB	Forward (Clockwise)	Reverse (Counter-Clockwise)
Main (Central)	Yes	No
Standby (Central)	No	Yes
Remote Standby	No	Yes
Remote Main	No	No

Based upon this, the program determines that the Remote Main EXB unit is bad.

Other possible causes for this display could be:

1. No power to the Remote Main EXB module.
2. A bad Main WAN line AND a bad Remote tie line.
 (Highly unlikely that two failures have occurred.)

However, the program flags these lines as questionable since it cannot determine that they are good.

6.8.5 Main (Central) EXB Failed

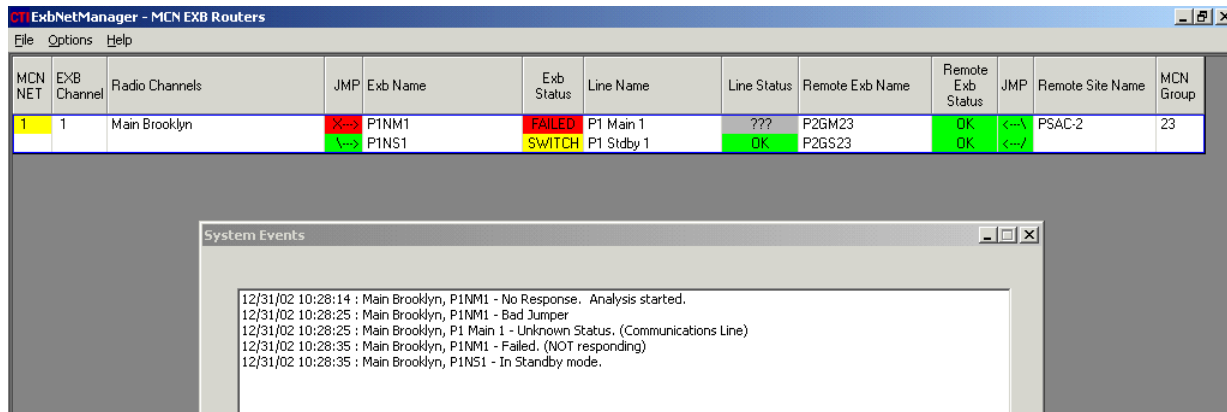

Figure 31 Main (Central) EXB Failed

Since the loop is not complete, the Standby EXB turns on its network switch to pass traffic over the Standby WAN line.

In this condition, the program can talk to the units as follows:

EXB	Forward (Clockwise)	Reverse (Counter-Clockwise)
Main (Central)	No	No
Standby (Central)	No	Yes
Remote Standby	No	Yes
Remote Main	No	Yes

Based upon this, the program determines that the Central Main EXB unit is bad.

Other possible causes for this display could be:

1. No power to the Central Main EXB module.
2. A bad Main WAN line AND a bad Central tie line.
 (Highly unlikely that two failures have occurred.)

However, the program flags these lines as questionable since it cannot determine that they are good.

6.8.6 Remote Tie Line Bad

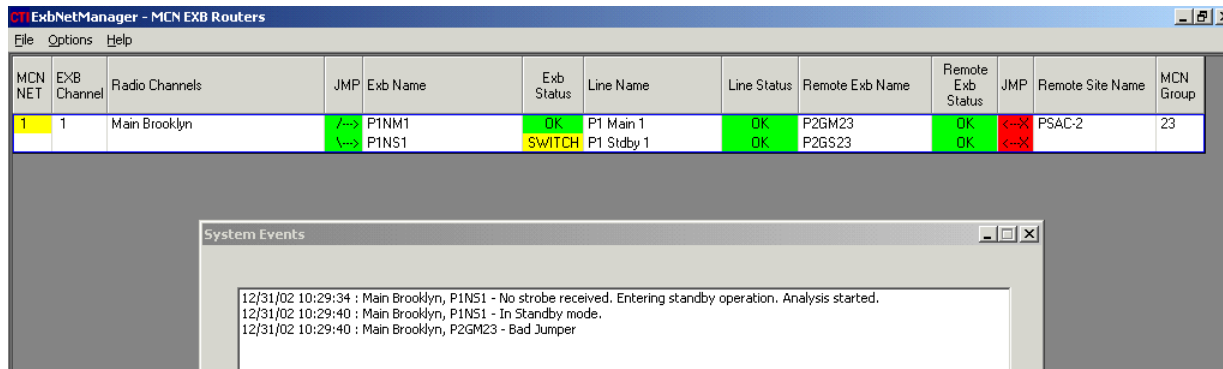

Figure 32 Remote Tie Line Bad

Since the loop is not complete, the Standby EXB turns on its network switch to pass traffic over the Standby WAN line.

In this condition, the program can talk to the units as follows:

EXB	Forward (Clockwise)	Reverse (Counter-Clockwise)
Main (Central)	Yes	No
Remote Main	Yes	No
Standby (Central)	No	Yes
Remote Standby	No	Yes

Based upon this, the program determines that the Remote Tie Line is bad.

6.8.7 Remote Standby EXB Failed

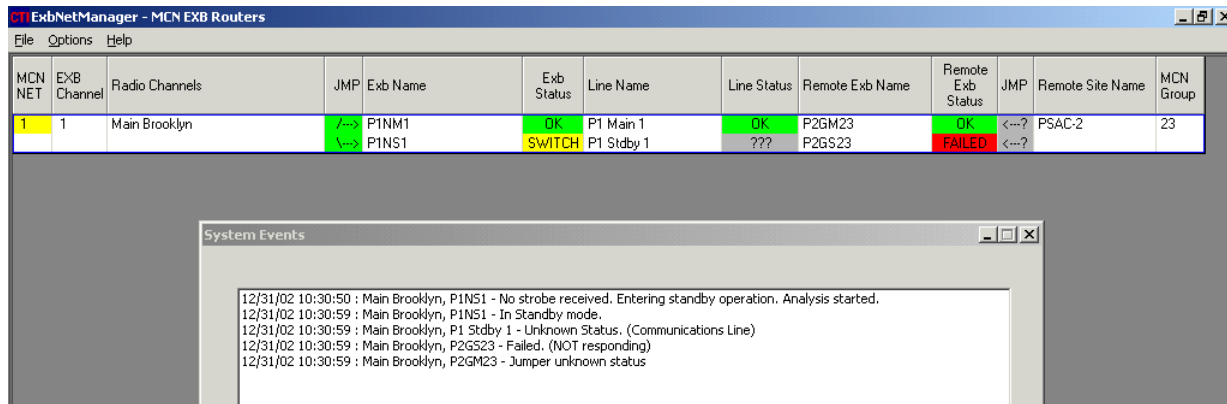

Figure 33 Remote Standby EXB Failed

Since the loop is not complete, the Standby EXB turns on its network switch to pass traffic over the Standby WAN line.

In this condition, the program can talk to the units as follows:

EXB	Forward (Clockwise)	Reverse (Counter-Clockwise)
Main (Central)	Yes	No
Remote Main	Yes	No
Standby (Central)	No	Yes
Remote Standby	No	No

Based upon this, the program determines that the Remote Standby EXB unit is bad.

Other possible causes for this display could be:

1. No power to the Remote Standby Main EXB module.
2. A bad Standby WAN line AND a bad Remote tie line.
(Highly unlikely that two failures have occurred.)

However, the program flags these lines as questionable since it cannot determine that they are good.

6.8.8 Standby WAN Line Bad

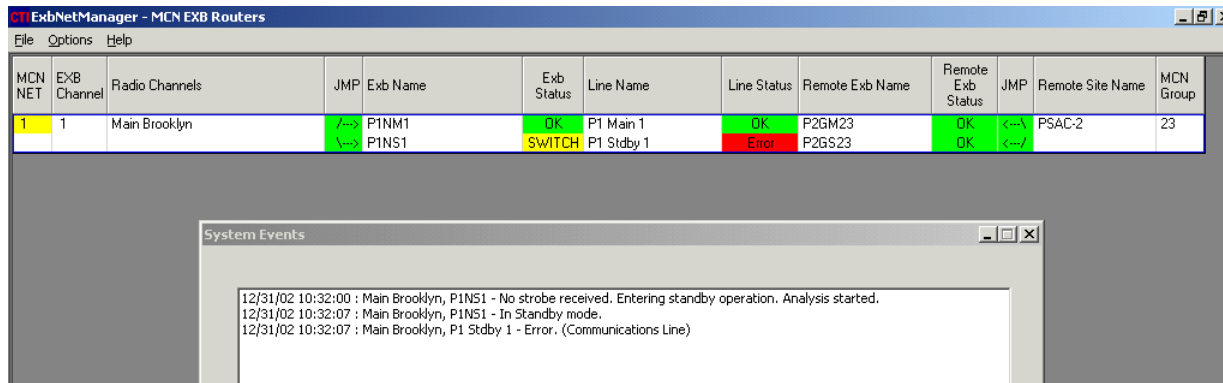

Figure 34 Standby WAN Line Bad

Since the loop is not complete, the Standby EXB turns on its network switch to pass traffic over the Standby WAN line.

In this condition, the program can talk to the units as follows:

EXB	Forward (Clockwise)	Reverse (Counter-Clockwise)
Main (Central)	Yes	No
Remote Main	Yes	No
Remote Standby	Yes	No
Standby (Central)	No	Yes

Based upon this, the program determines that the Standby WAN Line is bad.

Other possible causes for this display could be:

1. A bad cable from one of the Standby EXBs to the Standby WAN line.
2. Bad Standby or Standby Remote EXB Module.
 Possibly a bad modem in an Analog / Telco EXB unit
 Possibly a bad serial port on a Serial EXB unit.

6.8.9 Standby (Central) EXB Failed

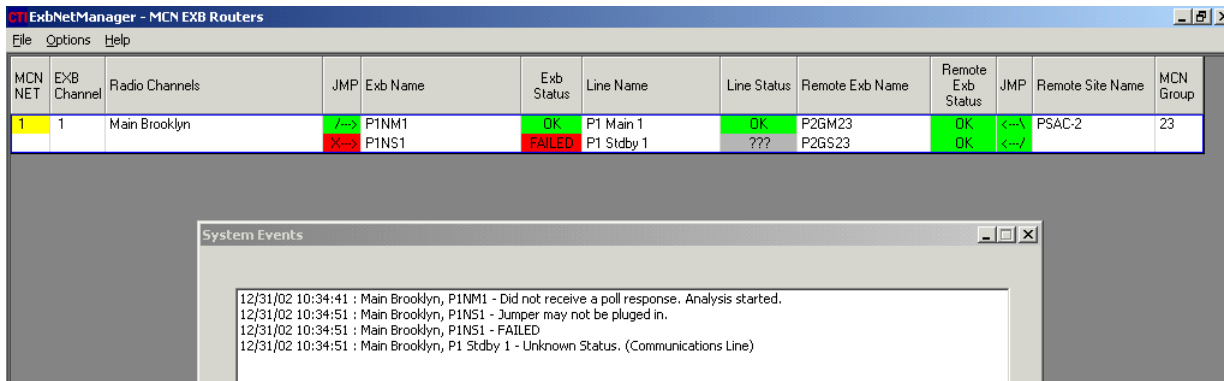

Figure 35 Standby (Central) EXB Failed

The program cannot talk to the Central Standby EXB unit.

In this condition, the program can talk to the units as follows:

EXB	Forward (Clockwise)	Reverse (Counter-Clockwise)
Main (Central)	Yes	No
Remote Main	Yes	No
Remote Standby	Yes	No
Standby (Central)	No	No

Based upon this, the program determines that the Central Standby EXB unit is bad.

Other possible causes for this display could be:

1. No power to the Central Standby EXB Unit
2. A bad cable Central Tie Line AND Standby WAN line
(Unlikely double failure)
3. A bad cable Central Tie Line AND Remote Standby EXB WAN problem
(Bad internal modem or RS-232 port)
(Unlikely double failure)

6.8.10 Central Tie Line Bad

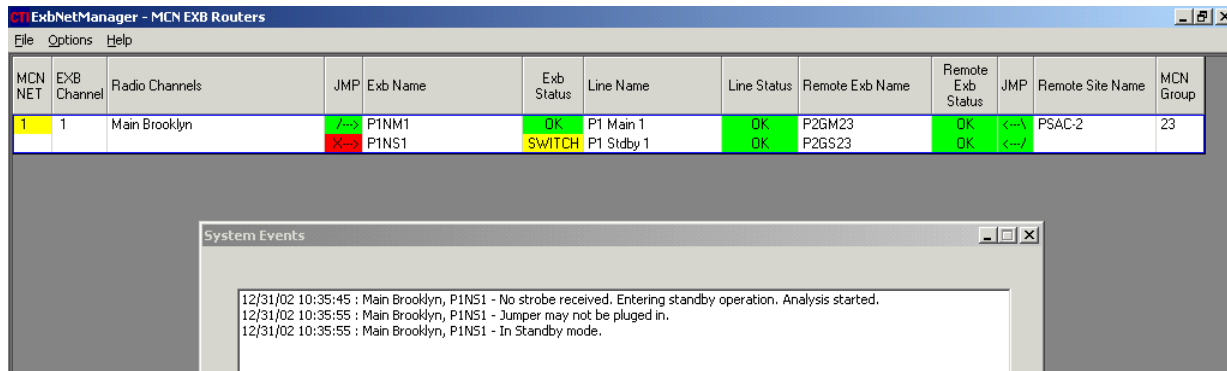

Figure 36 Central Tie Line Bad

Since the loop is not complete, the Standby EXB turns on its network switch to pass traffic over the Standby WAN line.

In this condition, the program can talk to the units as follows:

EXB	Forward (Clockwise)	Reverse (Counter-Clockwise)
Main (Central)	Yes	No
Remote Main	Yes	No
Remote Standby	Yes	No
Standby (Central)	Yes	No

Based upon this, the program determines that the Central Tie Line to the Standby EXB unit is bad.

Note that if the MCNRCD PCs at the central site are connected to the Standby EXB, they may actually be receiving data via the Standby path.

Other possible causes for this display could be:

1. Bad MCN Network port on the Standby EXB unit.

7. Appendix A -- Re-Installing the *EXB Network Management* Program

InstallShield does not always properly install a newer version of the *EXB Network Management Software* program over an old version. If you are installing an update for the program, you must remove the old version of the program first. Follow these instructions:

1. Close the *EXB Network Management* program.
2. Remove the old version of the *EXB Network Management* program :
Start → Settings → Control Panel → Add/Remove Programs
-Select the *EXB Network Management* program.
-Hit Change/Remove.
-Select Remove
-Hit Next.
3. Install the *EXB Network Management* program using the steps in Section 4, Software Installation.

8. Appendix B - Customer Support

If you need help in setting up your system, call one of our engineers at:
(513) 595-5900.

Ask to speak to a CTI Products, Inc. engineer.
Our hours are from 8:30 to 5:00 Eastern time.

